

Anderson & McQuaid Co, Inc.

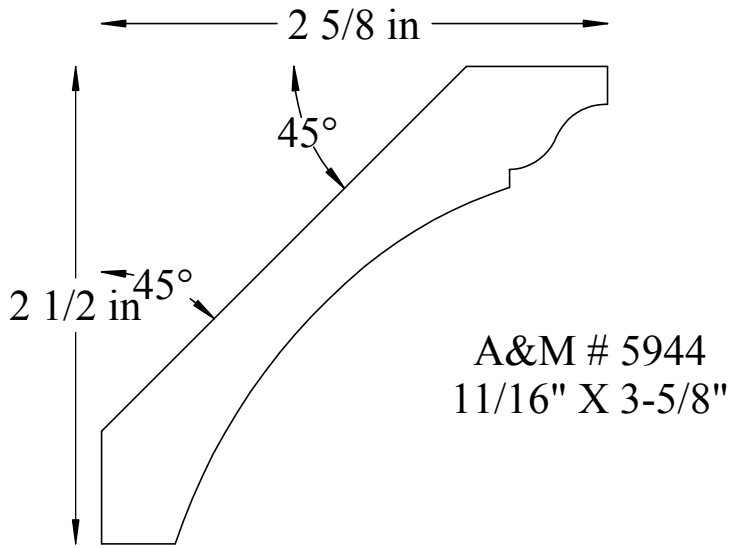

CROWN MOULDING MEASUREMENTS ARE
BASED ON THE THICKEST POINT IN THE
PROFILE x TIP TO TIP DIMENSION

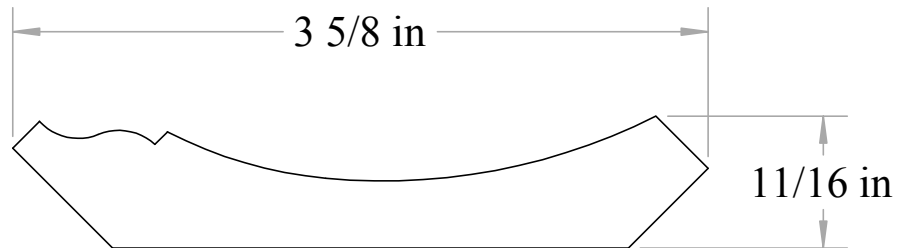

A&M # 5944
11/16" X 3-5/8"

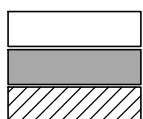

All unshaded profiles available in poplar
All shaded profiles available in poplar, cherry, maple, sapele and red oak.
All hatched profiles available in sapele