

# Anderson & McQuaid Co, Inc.

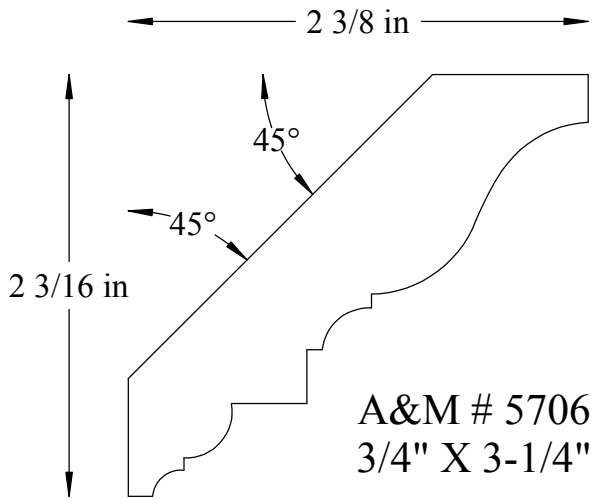

CROWN MOULDING MEASUREMENTS ARE  
BASED ON THE THICKEST POINT IN THE  
PROFILE x TIP TO TIP DIMENSION

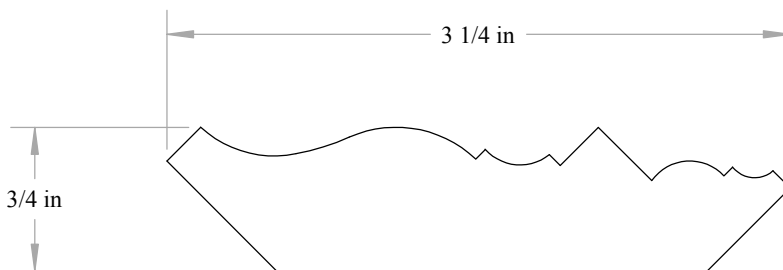

A&M # 5706  
3/4" X 3-1/4"

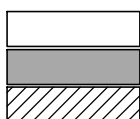

All unshaded profiles available in poplar  
All shaded profiles available in poplar, cherry, maple, sapele and red oak.  
All hatched profiles available in sapele