

# Anderson & McQuaid Co, Inc.

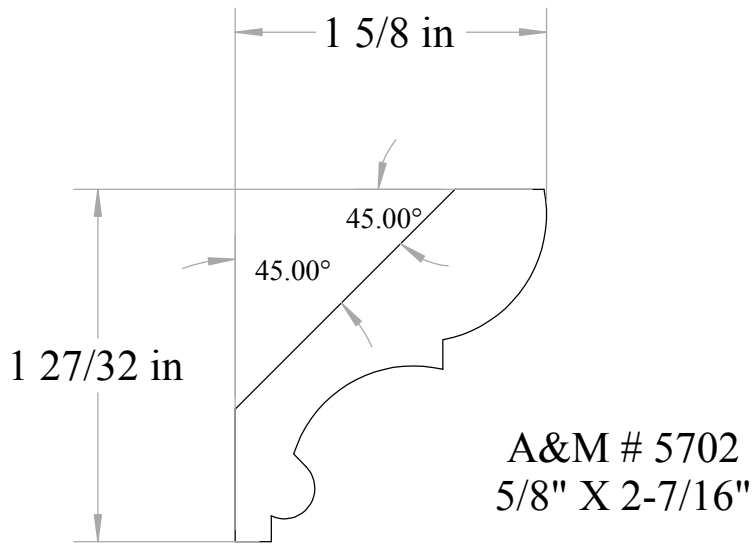

CROWN MOULDING MEASUREMENTS ARE  
BASED ON THE THICKEST POINT IN THE  
PROFILE x TIP TO TIP DIMENSION

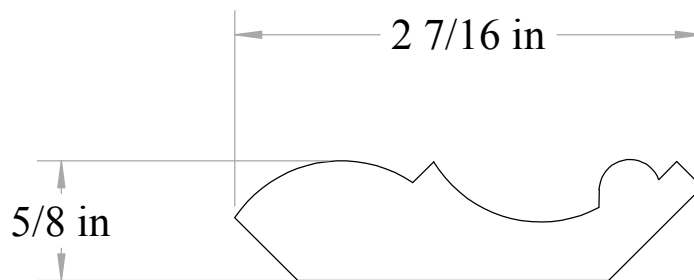

A&M # 5702  
5/8" X 2-7/16"

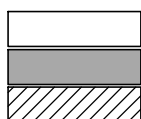

All unshaded profiles available in poplar

All shaded profiles available in poplar, cherry, maple, sapele and red oak.

All hatched profiles available in sapele