

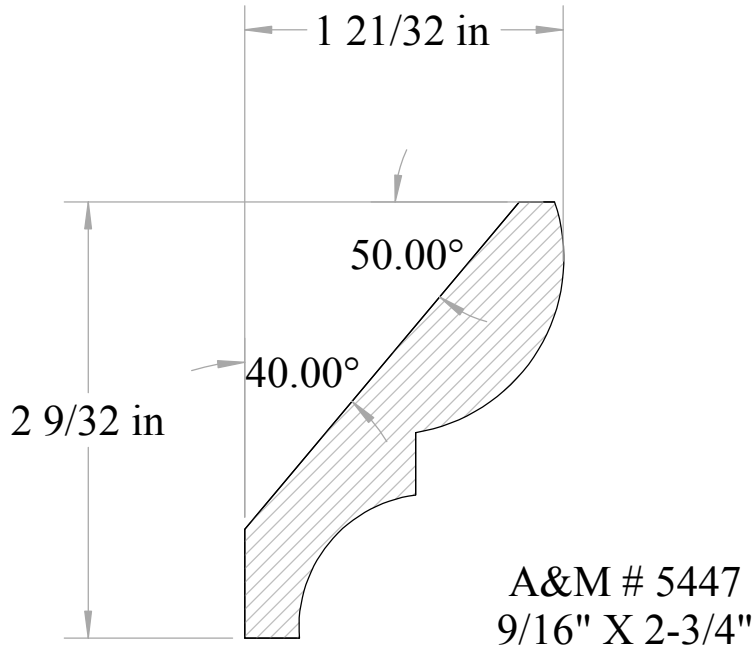

Anderson & McQuaid Co, Inc.

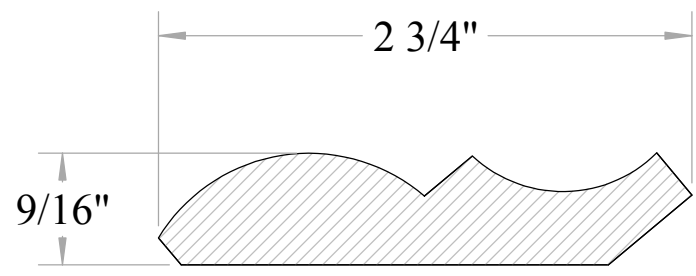

CROWN MOULDING MEASUREMENTS ARE
BASED ON THE THICKEST POINT IN THE
PROFILE x TIP TO TIP DIMENSION

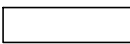

A&M # 5447
9/16" X 2-3/4"

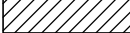
-  All unshaded profiles available in poplar
-  All shaded profiles available in poplar, cherry, maple, sapele and red oak.
-  All hatched profiles available in sapele