

Anderson & McQuaid Co, Inc.

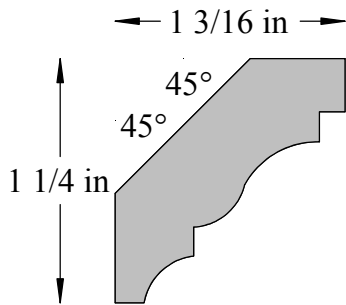

A&M # 5267
9/16" X 1-3/4"

CROWN MOULDING MEASUREMENTS ARE
BASED ON THE THICKEST POINT IN THE
PROFILE x TIP TO TIP DIMENSION

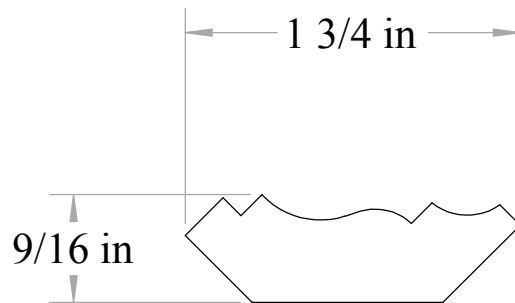

A&M # 5267
9/16" X 1-3/4"



All unshaded profiles available in poplar

All shaded profiles available in poplar, cherry, maple, sapele and red oak.

All hatched profiles available in sapele